











Δ delta 2,6 c

					
00.1063					
					
00.1066			28.2853 M1,4		
	29.6082	08.1730			
04.1596					
					
07.1674			28.2904 M1,4		
					
setnumber	version	front hinge	housing	gliding part	screw
60.2616.1B.1	delta 2,6 c 90° acetate	00.1063	29.6082	08.1730	28.2853
60.2616.1B.2	delta 2,6 c 180° acetate	00.1066	29.6082	08.1730	28.2853
60.2616.1C.1	delta 2,6 c combi	04.1596	29.6082	08.1730	28.2904
60.2616.1A.2	delta 2,6 c metal	07.1674	29.6082	08.1730	28.2904

Gliding part free of space, resistance against tearing out.

Housing

29.6082



System E16

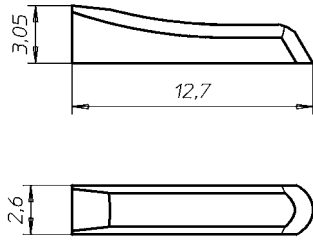

Front Hinge for Acetate 90°

00.1063

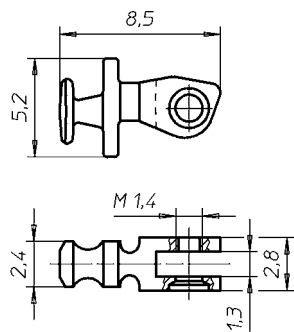

Front Hinge for Acetate 180°

00.1066

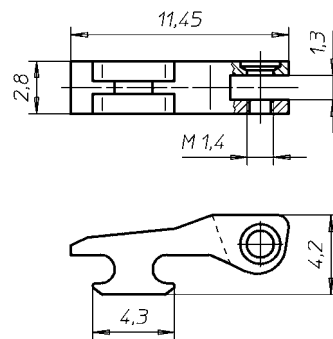

Front Hinge for Combination

04.1596

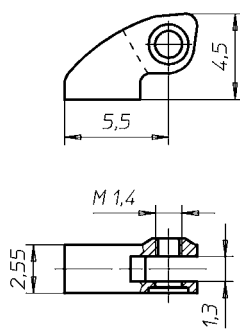

Front Hinge for Metal

07.1674

