



α alpha 2,1 s

setnumber	version	front hinge	housing	gliding part	screw
00.1033	alpha 2,1 s 90° soft	00.1033	29.60785	08.17195	28.2917
00.1036	alpha 2,1 s 180° soft	00.1036	29.60785	08.17195	28.2917
04.1474	alpha 2,1 s combi medium	04.1474	29.60785	08.16945	28.2917
07.1585	alpha 2,1 s metal medium	07.1585	29.60785	08.16945	28.2917
07.1605	alpha 2,1 s metal strong	07.1605	29.60785	08.17185	28.2927
07.1695	alpha 2,1 s metal strong	07.1695	29.60785	08.17185	28.2927

Gliding part replaceable, wide opening angle.

Housing

29.60785

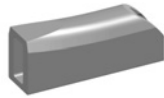
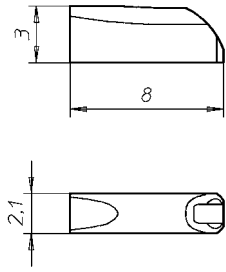

α
alpha
2,1 Short
System E7
Nickel Silver



Front Hinge for Acetate 90°

00.1033

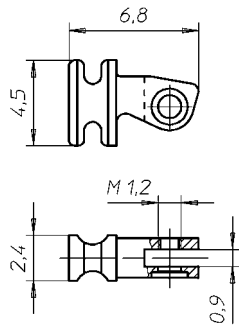

Front Hinge for Acetate 180°

00.1036

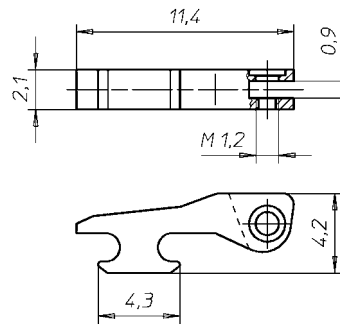

Front Hinge for Combination

04.1474

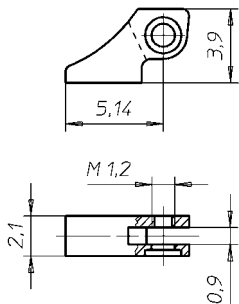

Front Hinge for Metal

07.1585

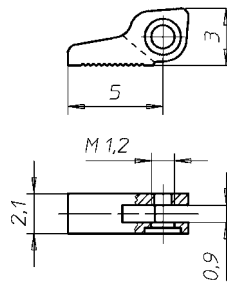

Front Hinge for Metal

07.1605

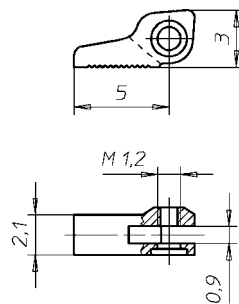

Front Hinge for Metal

07.1695

