



**α alpha 2,1 c**

setnumber	version	front hinge	housing	gliding part	screw
00.1033	α alpha 2,1 c 90° soft	00.1033	29.6061	08.1666	28.2917
00.1036	α alpha 2,1 c 180° soft	00.1036	29.6061	08.1666	28.2917
04.1474	α alpha 2,1 c combi soft	04.1474	29.6061	08.1666	28.2917
07.1585	α alpha 2,1 c metal medium	07.1585	29.6061	08.1664	28.2917
07.1605	α alpha 2,1 c metal strong	07.1605	29.6061	08.1586	28.2927
07.1695	α alpha 2,1 c metal strong	07.1695	29.6061	08.1586	28.2927

Gliding part replaceable, wide opening angle.

Housing

29.6061

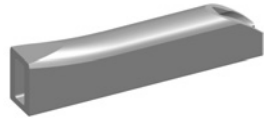
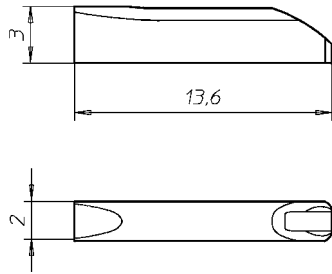

**α**  
alpha  
2,1  
Classic  
System E7  
Nickel Silver



Front Hinge for Acetate 90°

00.1033

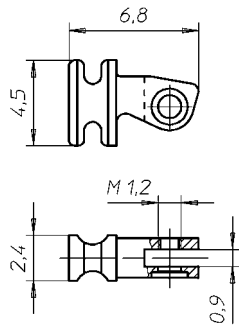

Front Hinge for Acetate 180°

00.1036

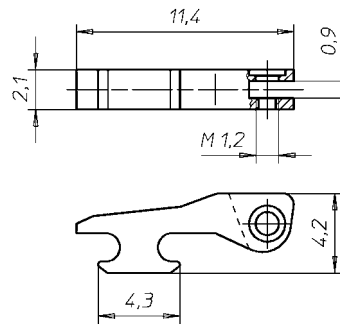

Front Hinge for Combination

04.1474

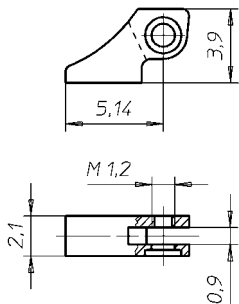

Front Hinge for Metal

07.1585

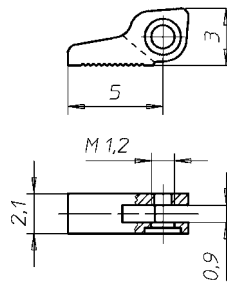

Front Hinge for Metal

07.1605

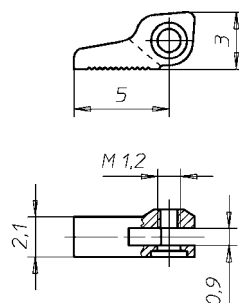

Front Hinge for Metal

07.1695

