

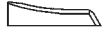

E20 Arty 3,0

| | | | | | |
|---|---|---|---|--------------|---------|
|  |  |  |  | | |
| Endpiece | Housing | Gliding part | Screw | | |
| 16.0680 | 29.6087.101-134 | 08.1735 | 28.3154 | | |
| nickel silver Width: 3,0 mm | nickel silver Width: 3,0 mm | nickel silver | stainless steel | | |
| setnumber | version | endpiece | housing/decors | gliding part | screw |
| 60.3020.2A.1 X X | E20 Arty 3.0 | 16.0680 | 29.6087.101-134 | 08.1735 | 28.3154 |
| Self-clipping flex system, Spring hinge double action, esthetic and innovative. Available in various decors. Spring hinge double action, esthetic and innovative. Available in various decors. | | | | | |

Endpiece

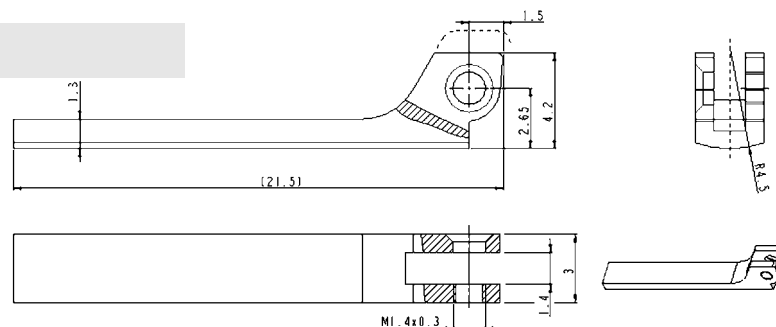

E20 Arty - 3,0 mm

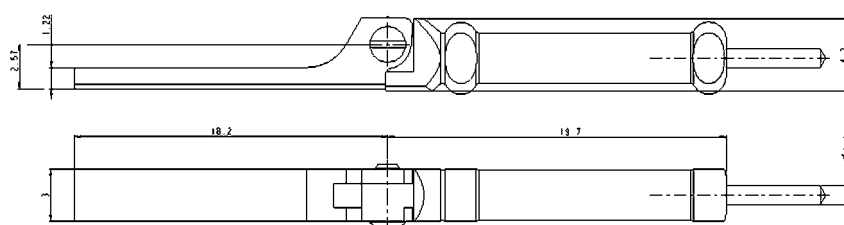

**E20 Arty 3,0
DECORS AVAILABLE**

Dec. 100



Dec. 101

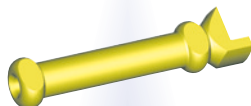

Dec. 102



Dec. 103

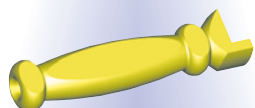

Dec. 104

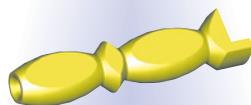

Dec. 105

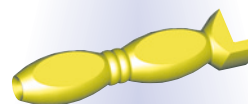

Dec. 106

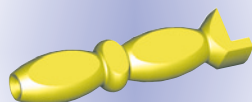

Dec. 107



Dec. 108

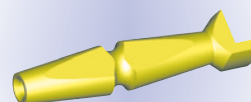

Dec. 109

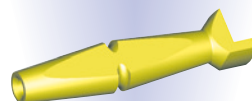

Dec. 110

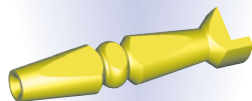

Dec. 111

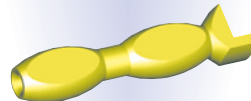

Dec. 112



Dec. 113



Dec. 117



**E20 Arty 3,0
DECORS AVAILABLE**

